



Quad 1.5 A Sinking High Current Switch

The ULN2068B is a high-voltage, high-current quad Darlington switch array designed for high current loads, both resistive and reactive, up to 300 W.

It is intended for interfacing between low level (TTL, DTL, LS and 5.0 V CMOS) logic families and peripheral loads such as relays, solenoids, dc and stepping motors, multiplexer LED and incandescent displays, heaters, or other high voltage, high current loads.

The Motorola ULN2068B is specified with minimum guaranteed breakdown of 50 V and is 100% tested for safe area using an inductive load. It includes integral transient suppression diodes. Use of a predriver stage reduces input current while still allowing the device to switch 1.5 Amps.

It is supplied in an improved 16-Pin plastic DIP package with heat sink contact tabs (Pins 4, 5, 12 and 13). A copper alloy lead frame allows maximum power dissipation using standard cooling techniques. The use of the contact tab lead frame facilitates attachment of a DIP heat sink while permitting the use of standard layout and mounting practices.

- TTL, DTL, LS, CMOS Compatible Inputs
- 1.5 A Maximum Output Current
- Low Input Current
- Internal Freewheeling Clamp Diodes
- 100% Inductive Load Tested
- Heat Tab Copper Alloy Lead Frame for Increased Dissipation

MAXIMUM RATINGS ($T_A = 25^\circ\text{C}$ and ratings apply to any one device in the package, unless otherwise noted)

Rating	Symbol	Value	Unit
Output Voltage	V_O	50	V
Input Voltage (Note 1)	V_I	15	V
Supply Voltage	V_S	10	V
Collector Current (Note 2)	I_C	1.75	A
Input Current (Note 3)	I_I	25	mA
Operating Ambient Temperature Range	T_A	0 to +70	$^\circ\text{C}$
Storage Temperature Range	T_{stg}	-55 to +150	$^\circ\text{C}$
Junction Temperature	T_J	150	$^\circ\text{C}$

- NOTES:** 1. Input voltage referenced to ground.
 2. Allowable output conditions shown in Figures 11 and 12.
 3. May be limited by max input voltage.

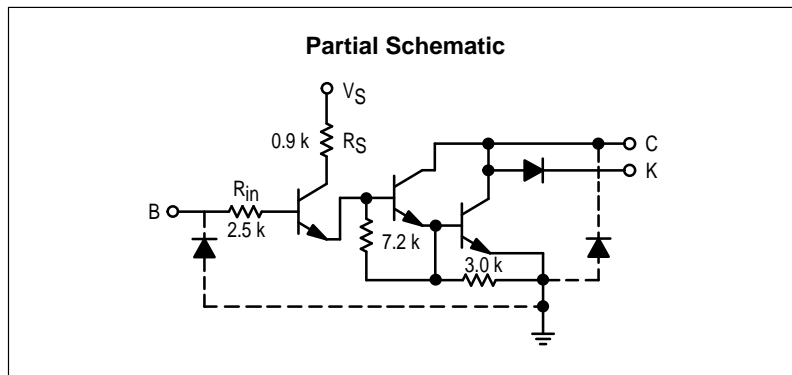

ULN2068

QUAD 1.5 A DARLINGTON SWITCH

SEMICONDUCTOR TECHNICAL DATA

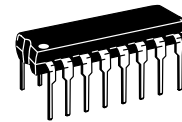

B SUFFIX
 PLASTIC PACKAGE
 CASE 648C

PIN CONNECTIONS

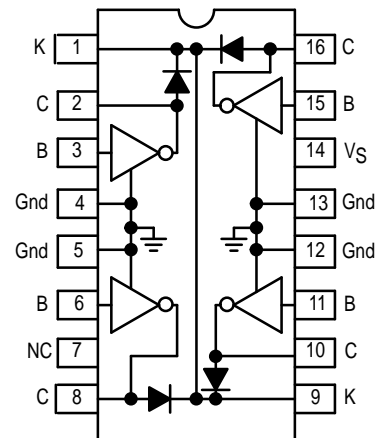

ORDERING INFORMATION*

Device	Operating Temperature Range	Package
ULN2068B	$T_A = 0$ to $+70^\circ\text{C}$	Plastic DIP

*Other options of this ULN2060/2070 series are available for volume applications. Contact your local Motorola Sales Representative.

ULN2068

ELECTRICAL CHARACTERISTICS (T_A = 25°C unless otherwise noted.)

Characteristic	Symbol	Min	Typ	Max	Unit
Output Leakage Current (Figure 1) (V _{CE} = 50 V) (V _{CE} = 50 V, T _A = 70°C)	I _{CEX}	–	–	100 500	μA
Collector–Emitter Saturation Voltage (Figure 2) (I _C = 500 mA) (I _C = 750 mA) (I _C = 1.0 A) (I _C = 1.25 A) } V _{in} = 2.4 V	V _{CE(sat)}	–	–	1.13 1.25 1.40 1.60	V
Input Current – On Condition (Figure 4) (V _I = 2.4 V) (V _I = 3.75 V)	I _{I(on)}	–	–	0.25 1.0	mA
Input Voltage – On Condition (Figure 5) (V _{CE} = 2.0 V, I _C = 1.5 A)	V _{I(on)}	–	–	2.4	V
Inductive Load Test (Figure 3) (V _S = 5.5 V, V _{CC} = 24.5 V, t _{PW} = 4.0 ms)	ΔV _{out}	–	–	100	mV
Supply Current (Figure 8) (I _C = 500 mA, V _{in} = 2.4 V, V _S = 5.5 V)	I _S	–	–	6.0	mA
Turn–On Delay Time (50% E _I to 50% E _O)	t _{PHL}	–	–	1.0	μs
Turn–Off Delay Time (50% E _I to 50% E _O)	t _{PLH}	–	–	4.0	μs
Clamp Diode Leakage Current (Figure 6) (V _R = 50 V) (V _R = 50 V, T _A = 70°C)	I _R	–	–	50 100	μA
Clamp Diode Forward Voltage (Figure 7) (I _F = 1.0 A) (I _F = 1.5 A)	V _F	–	–	1.75 2.0	V

TEST FIGURES

Figure 1.

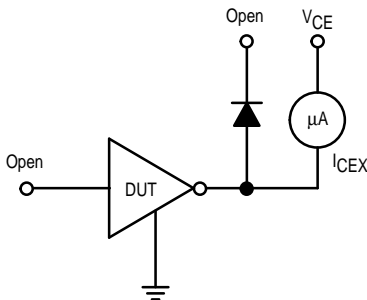

Figure 2.

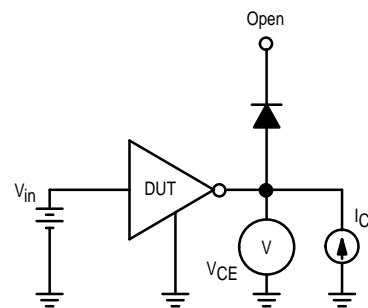

Figure 3.

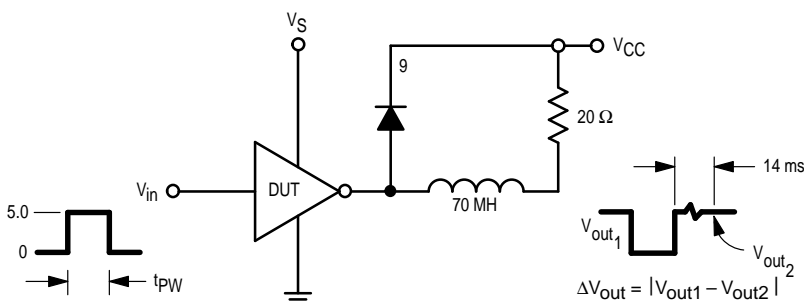
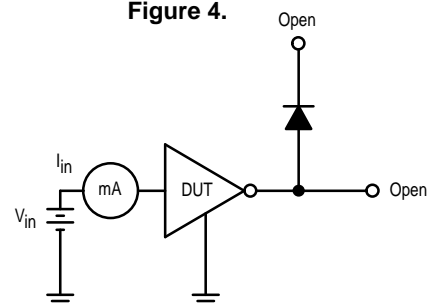

Figure 4.



TEST FIGURES (continued)

Figure 5.

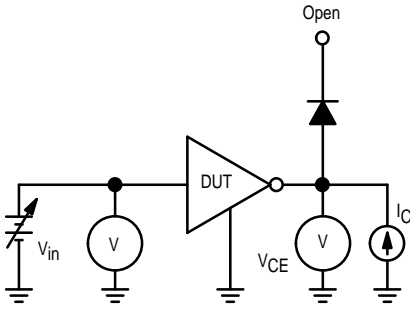

Figure 6.

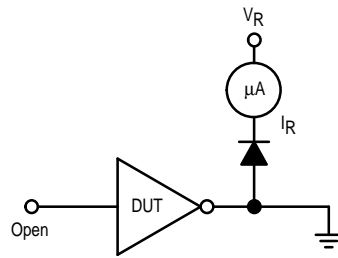

Figure 8.

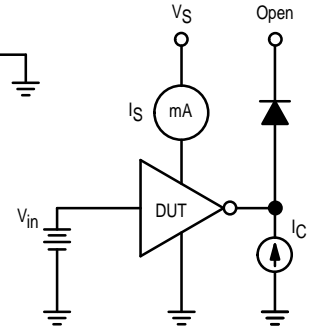
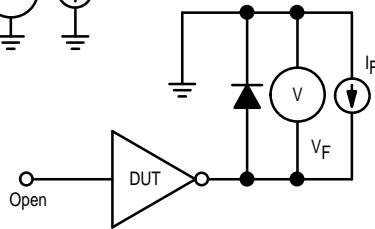

Figure 7.



TYPICAL CHARACTERISTIC CURVES – $T_A = 25^\circ\text{C}$

Figure 9. Input Current versus Input Voltage

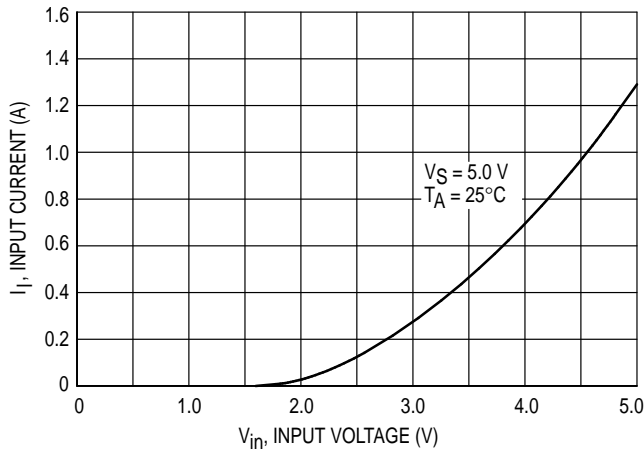

Figure 10. Collector Current versus Input Current

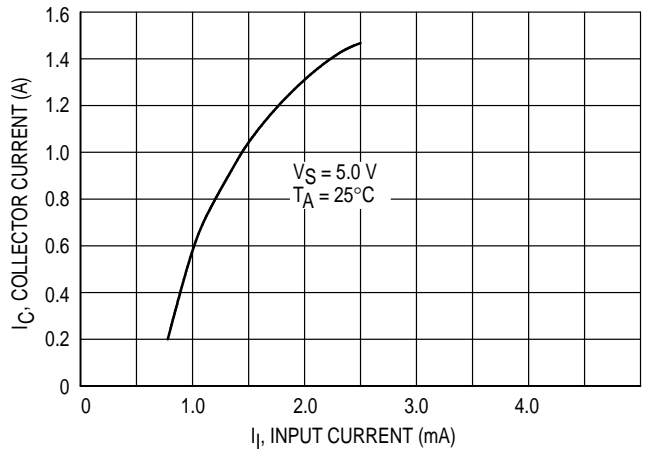

Figure 11. $T_A = 70^\circ\text{C}$ w/o Heat Sink

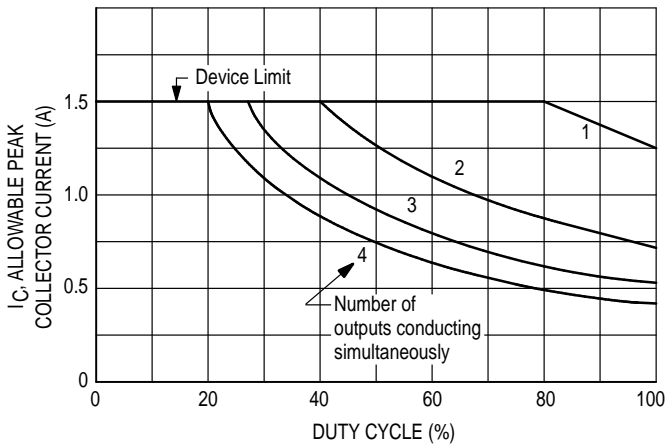

Figure 12. $T_A = 70^\circ\text{C}$ w/Staver V-8 Heat Sink (37.5°C/W)

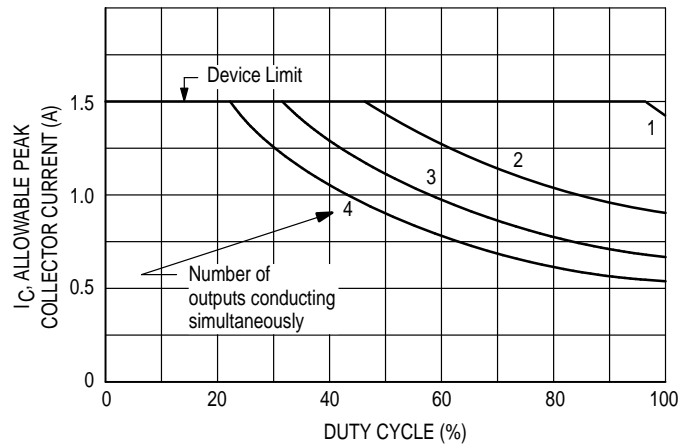

Figure 13. $T_A = 70^\circ\text{C}$ w/Staver V-7
Heat Sink (27.5°C/W)

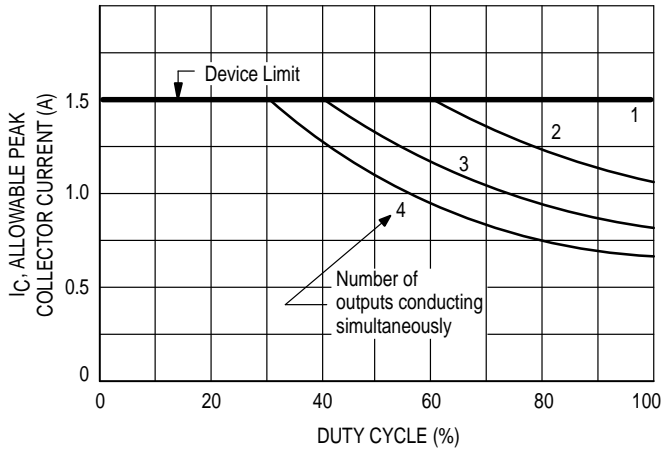

Figure 14. $T_A = 50^\circ\text{C}$ w/o Heat Sink

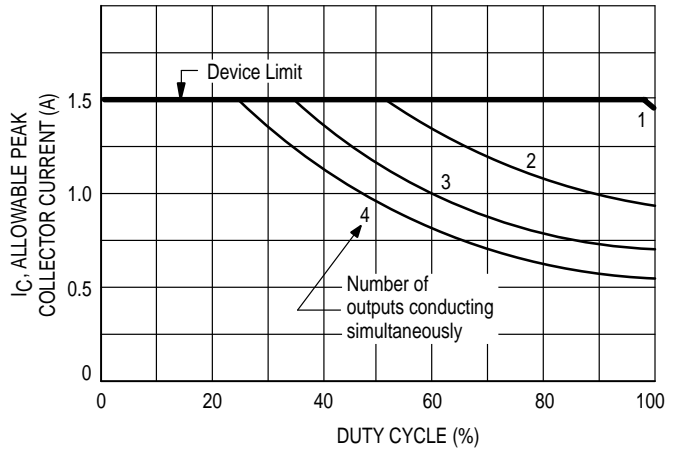

Figure 15. $T_A = 50^\circ\text{C}$ w/Staver V-8
Heat Sink (37.5°C/W)

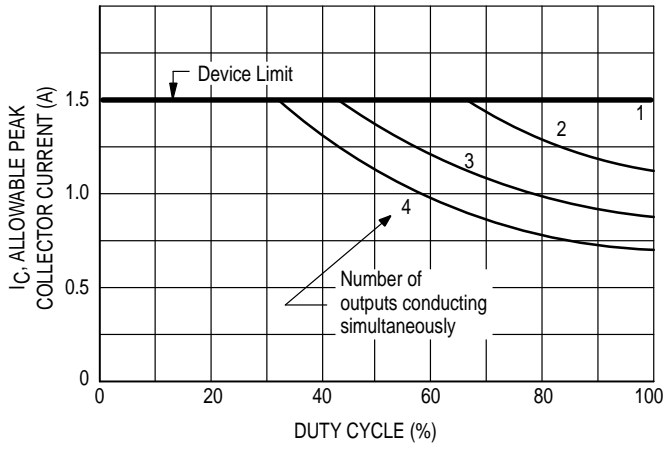
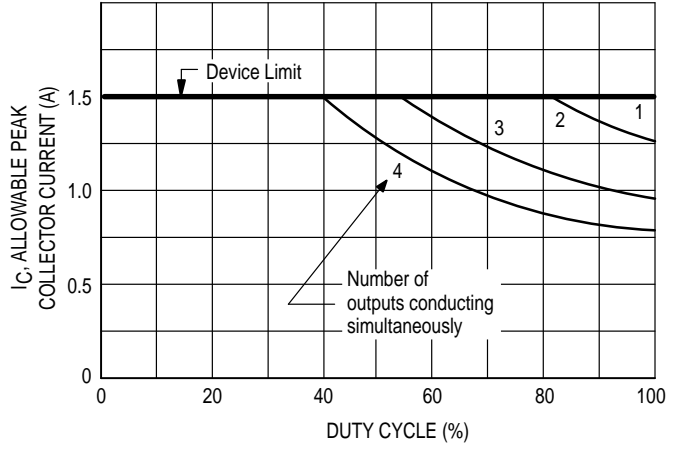

Figure 16. $T_A = 50^\circ\text{C}$ w/Staver V-7
Heat Sink (27.5°C/W)



ULN2068

OUTLINE DIMENSIONS

B SUFFIX
PLASTIC PACKAGE
CASE 648C-03
ISSUE C

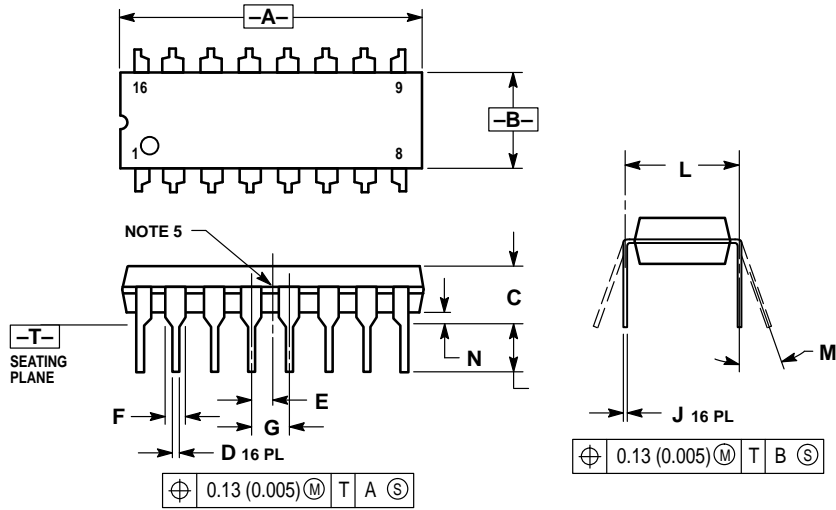

NOTES:

1. DIMENSIONING AND TOLERANCING PER ANSI Y14.5M, 1982.
2. CONTROLLING DIMENSION: INCH.
3. DIMENSION L TO CENTER OF LEADS WHEN FORMED PARALLEL.
4. DIMENSION B DOES NOT INCLUDE MOLD FLASH.
5. INTERNAL LEAD CONNECTION BETWEEN 4 AND 5, 12 AND 13.

DIM	INCHES		MILLIMETERS	
	MIN	MAX	MIN	MAX
A	0.740	0.840	18.80	21.34
B	0.240	0.260	6.10	6.60
C	0.145	0.185	3.69	4.69
D	0.015	0.021	0.38	0.53
E	0.050 BSC		1.27 BSC	
F	0.040	0.70	1.02	1.78
G	0.100 BSC		2.54 BSC	
J	0.008	0.015	0.20	0.38
K	0.115	0.135	2.92	3.43
L	0.300 BSC		7.62 BSC	
M	0°	10°	0°	10°
N	0.015	0.040	0.39	1.01

ULN2068

Motorola reserves the right to make changes without further notice to any products herein. Motorola makes no warranty, representation or guarantee regarding the suitability of its products for any particular purpose, nor does Motorola assume any liability arising out of the application or use of any product or circuit, and specifically disclaims any and all liability, including without limitation consequential or incidental damages. "Typical" parameters can and do vary in different applications. All operating parameters, including "Typicals" must be validated for each customer application by customer's technical experts. Motorola does not convey any license under its patent rights nor the rights of others. Motorola products are not designed, intended, or authorized for use as components in systems intended for surgical implant into the body, or other applications intended to support or sustain life, or for any other application in which the failure of the Motorola product could create a situation where personal injury or death may occur. Should Buyer purchase or use Motorola products for any such unintended or unauthorized application, Buyer shall indemnify and hold Motorola and its officers, employees, subsidiaries, affiliates, and distributors harmless against all claims, costs, damages, and expenses, and reasonable attorney fees arising out of, directly or indirectly, any claim of personal injury or death associated with such unintended or unauthorized use, even if such claim alleges that Motorola was negligent regarding the design or manufacture of the part. Motorola and  are registered trademarks of Motorola, Inc. Motorola, Inc. is an Equal Opportunity/Affirmative Action Employer.

How to reach us:

USA / EUROPE: Motorola Literature Distribution;
P.O. Box 20912; Phoenix, Arizona 85036. 1-800-441-2447

JAPAN: Nippon Motorola Ltd.; Tatsumi-SPD-JLDC, Toshikatsu Otsuki,
6F Seibu-Butsuryu-Center, 3-14-2 Tatsumi Koto-Ku, Tokyo 135, Japan. 03-3521-8315

MFAX: RMFAX0@email.sps.mot.com - TOUCHTONE (602) 244-6609
INTERNET: <http://Design-NET.com>

HONG KONG: Motorola Semiconductors H.K. Ltd.; 8B Tai Ping Industrial Park,
51 Ting Kok Road, Tai Po, N.T., Hong Kong. 852-26629298



ULN2068/D



This datasheet has been download from:

www.datasheetcatalog.com

Datasheets for electronics components.